

Haier

*LED LCD TV
OWNER'S MANUAL
MODEL: LE42A6500GA*

Haier

Please READ this manual carefully
before operating your TV, and retain
it for future reference

The Haier logo consists of the word "Haier" in a white, sans-serif font, centered within a solid gray square.

Contents

1. Safety and warnings.....	2-3
2. Introduction.....	4
3. Wall Mount Installation.....	5
4. Installation.....	6-8
5. Remote Control.....	9-10
6. Operation.....	11-20
7. Trouble Shooting.....	21

IMPORTANT SAFETY INSTRUCTION

- 1) Read these instructions.
- 2) Keep these instructions.
- 3) Heed all warnings.
- 4) Follow all instructions.
- 5) Do not use this apparatus near water.
- 6) Clean only with dry cloth.
- 7) Do not block any ventilation openings, install in accordance with the instructions.
- 8) Do not install near any heat sources such as radiations, heat registers, stoves, or other apparatus (including amplifiers) that produce heat.
- 9) Do not defeat the safety purpose of the polarized plug. If the provided plug does not fit into your outlet, consult an electrician for replacement of the obsolete outlet.
- 10) Protected the power cord from being walked on or pinched particularly at plugs, convenience receptacles, and the point where they exit from the apparatus.
- 11) Only use attachments/accessories specified by the manufacturer.
- 12) Unplug this apparatus during lightning storms or when unused for long periods of time.
- 13) Refer all servicing to qualified service personnel. Servicing is required when the apparatus has been damaged in any way, such as power-supply cord or plug is damaged, liquid has been spilled or objects have fallen into the apparatus, the apparatus has been exposed to rain or moisture, does not operate normally, or has been dropped.
- 14) Mains plug is used as the disconnect device, the disconnect device shall remain readily operable.
- 15) The ventilation should not be impeded by covering the ventilation openings with items, such as newspapers, table-cloth, curtains, etc.
- 16) No naked flame sources, such as lighted candles, should be placed on the apparatus.
- 17) Attention should be drawn to the environmental aspects of battery disposal.
- 18) The use of apparatus in moderate climate.
- 19) The apparatus shall not be exposed to dripping or splashing and that no objects filled with liquids, such as vases, shall be placed on the apparatus.
- 20) Warning: To avoid any injury caused by lean of the product, please always ensure the whole product was placed within the table surface in horizontal.



 The symbol indicates that dangerous voltages constituting a risk of electric shock are present within this unit.

 The symbol indicates that there are important operating and maintenance instructions in the literature accompanying this unit.

WARNING:

To reduce the risk of fire or electric shock, do not expose this apparatus to rain or moisture.

WARNING:

The batteries shall not be exposed to excessive heat such as sunshine, fire or the like.



This symbol indicates that this product incorporates double insulation between hazardous mains voltage and user accessible parts. When servicing use only identical replacement parts.



This marking indicates that this product should not be disposed with other household wastes throughout the EU. To prevent possible harm to the environment or human health from uncontrolled waste disposal, recycle it responsibly to promote the sustainable reuse of material resources. To return your used device, please use the return and collection systems or contact the retailer where the product was purchased. They can take this product for environmental safe recycling.



High voltages are used in the operation of this television receiver. Do not remove the cabinet back from your set. Refer servicing to qualified service personnel.



Never stand on, lean on, or suddenly push the television or its stand. You should pay special attention to children. Serious injury may result if it falls.

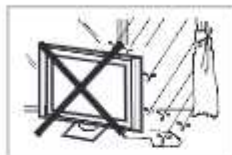

To prevent fire or electrical shock hazard, do not expose the television receiver to rain or moisture.

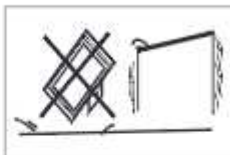

Do not place your television on an unstable cart, stand, shelf or table. Serious injury to an individual, and damage to the television, may result if it falls.



Do not drop or push objects into the television cabinet slots or openings. Never spill any kind of liquid on the television receiver.



When the television receiver is not used for an extended period of time, it is advisable to disconnect the AC power cord from the AC outlet.



Do not block the ventilation holes in the back cover. Adequate ventilation is essential to prevent failure of electrical components.



Avoid exposing the television receiver to direct sunlight and other sources of heat. Do not stand the television receiver directly on other products which give off heat, e.g. video cassette players and audio amplifiers. Do not place naked flame sources, such as lighted candles on the television.



Do not trap the power supply cord under the television receiver.



If the television is to be built into a compartment or similar enclosure, the minimum distances must be maintained. Heat build-up can reduce the service life of your television, and can also be dangerous.



If you are going to clean the product, Unplug the TV, use soft fabric, no water, never chemicals.

Main features

- ① Used as Television, display terminal;
- ② High luminance, wide viewing angle;
- ③ Can store Air and Cable TV programs;
- ④ HDMI interface;
- ⑤ Multi-Media player (USB);

Accessories

Remote Controller.....	1
User's Manual.....	1
E-waste Guideline Manual.....	1
Warranty Card.....	1
QSG.....	1
Stand Screws.....	4

Main parameter

Viewing Picture Size (Diagonal)	105cm
Resolution	1920x1080
Aspect Ratio	16 : 9
TV System	PAL-B/G, DVB-T(optional), DVB-C(optional), DVB-T2(optional)
Video Signal System	PAL/NTSC/SECAM
Receiving Channel	DVB-T2:1000, DVB-C:1000, ATV:99
Input Power Voltage	100-240V- 50/60Hz
Power consumption	68W
Audio Output Power	2 x8W
Signal input/output	High-Definition Multimedia Interface(HDMI) x 3 Composite Video Input x 1 Audio Input x 1 LAN Input x 1 YCb (Pb)Cr (Pr) x 1 USB x 2 OPTICAL OUTPUT x 1 HEADPHONE OUTPUT x 1 RF x 1 TP x 1
Horizontal definition (TV line)	Composite Video input >=350 Y.Cb(Pb) Cr(Pr) >=400

Note: This product uses a panel consisting of sub pixels which require sophisticated technology to produce. However, there may be a few bright or dark pixels on the screen. These pixels will have no impact on the performance of the product.



Unplug the television, use soft fabric, never chemicals, if you are going to make cleaning of the product. Make sure that no water drops in the product.

HDMI[®]
HIGH DEFINITION MULTIMEDIA INTERFACE

The terms HDMI and HDMI High-Definition Multimedia Interface, and the HDMI Logo are trademarks or registered trademarks of HDMI Licensing Administrator, Inc. in the United States and other countries.

Step One: Use the expansion bolts(4*36PWA) to fix the wall mount brackets into the wall.

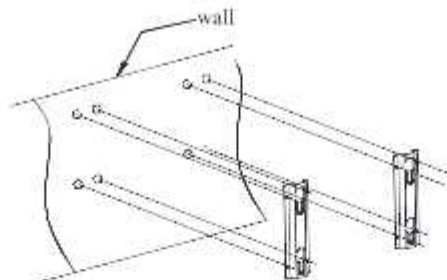

Step Two: Fix the wall mount screws (M6x8mm/4pcs) into the rear side of the LED TV, using the tongue of 8kgf.cm.

* The TV appearance subject to material object.

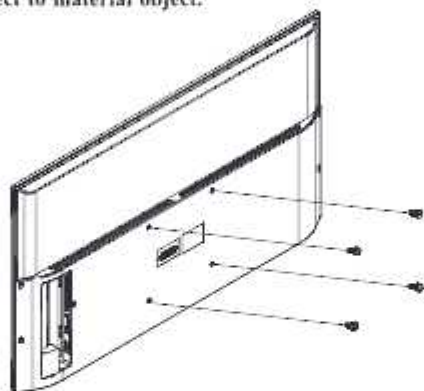

Step Three: Put the LED TV with wall mount screws onto the wall mount brackets.

Warning: the angle between the TV and wall must not be bigger than 3°.

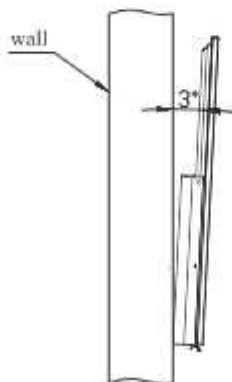

Front panel

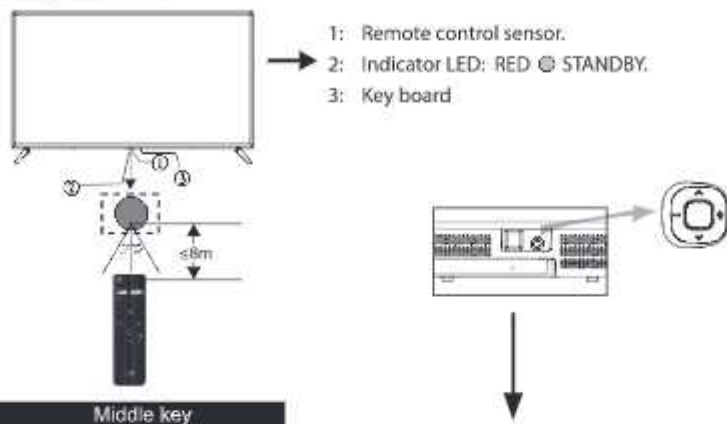

Middle key

In the standby mode, press the middle button to turn on the TV.
 In the boot state, short press the middle button to shut down.
 Under the menu page, function equivalent to the OK key.

Left and right keys

In the non-menu page, Under the menu page, press the left and right keys to adjust the volume addition and subtraction.

Up and down keys

In the non-menu page, you can adjust the TV channel under the program addition and subtraction;
 Under the menu page, you can move the cursor up and down.

REAR AV Connections (SIDE)



All the terminals are (from left to right):
 HDMI(Arc), ANT IN, USB, TF, EARPHONE output.

REAR AV Connections



All the terminals are (from left to right):
 RJ45, OPTICAL output, AUDIO input(L/R), VIDEO, YPbPr Input, HDMI3, HDMI2.

Note:

VIDEO and YPbPr share one audio channel.

When HDMI port get DVI signal, the audio signal receives from the AV Audio channel.

ANTENNA

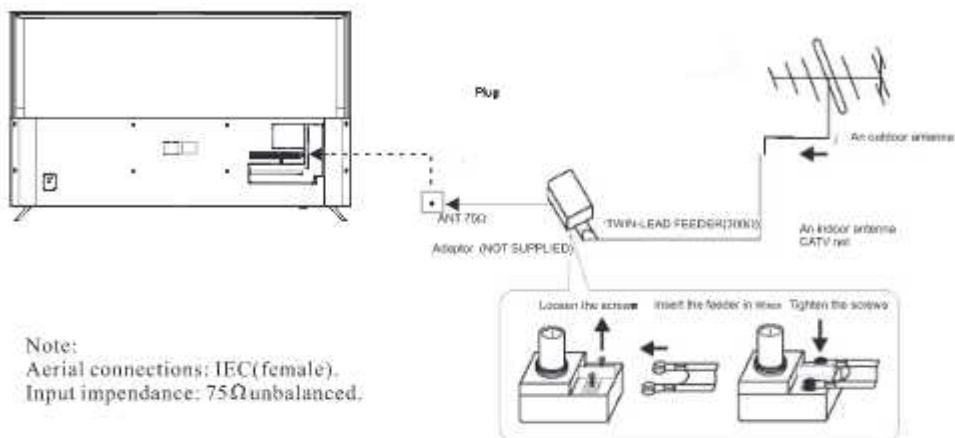

Note:
Aerial connections: IEC(female).
Input impedance: 75Ω unbalanced.

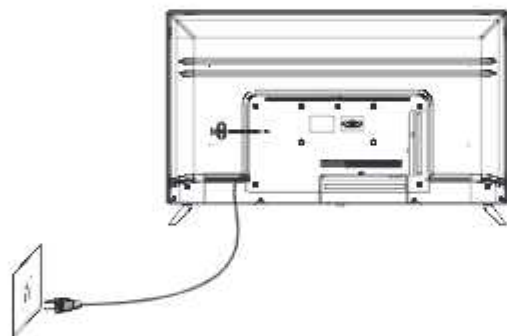

PRESET MODE (HDMI)

	RESOLUTION	V.Freq (Hz)	H.Freq (kHz)
1	800*600	60	37.50
2	1024*768	60	48.36
3	1360*768	60	47.7
4	1280*768	60	47.7
5	1920*1080	60	67.5

AV EQUIPMENT

This TV provides one group of AV, one group of YPbPr for convenient connection to VCR, DVD or other video equipment. Please refer to the owner's manual of the equipment to be connected as well. You can use the input terminals on TV set rear as follows.

- ⦿ Yellow (video)
- ⦿ Red (audio R)
- ⦿ White (audio L)
- ⦿ Red/Pr or Cr
- ⦿ Blue/Pb or Cb
- ⦿ Green/Y

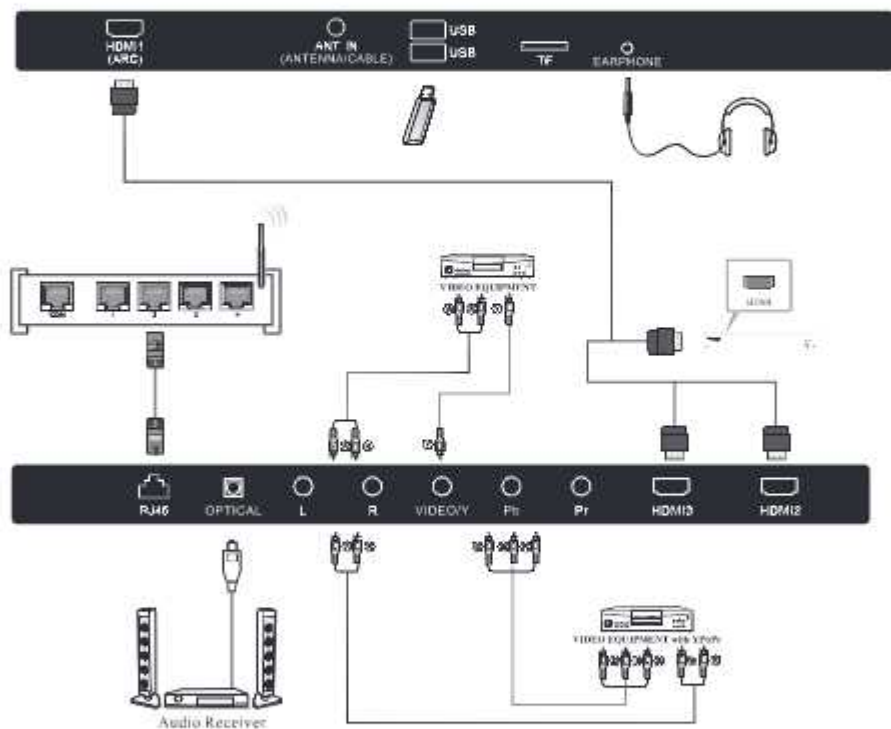

It can be connected to the following appliances: VCR, multi disc player, DVD, camcorder, video game or stereo system, etc.....

YPbPr can support these video formats:480i,576i,480p,576p,720p,1080i,1080P.

Note:

1. AV and YPbPr share one audio channel.
2. When HDMI port get DVI signal, the "AV Audio" channel is changed to receive the audio for HDMI port.
3. Sometimes it will not support in different device because the device supplies nonstandard signal.

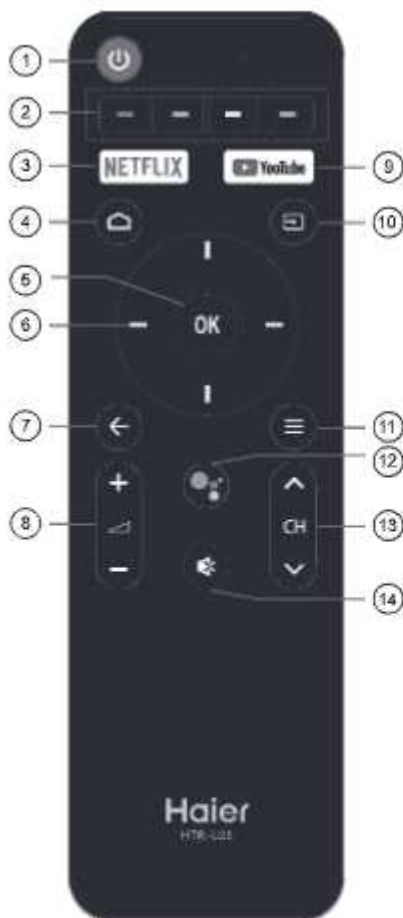

#	Item	Descriptions
1	Power	Press to turn the TV on or off. When your TV is off, power still flows through it. To completely disconnect power, unplug the power cord.
2	Coloured buttons	Implement the relevant operations according to the prompt at the bottom of the menu in the text.
3	NETFLIX	Press to open the NETFLIX.
4	HOME	Press to open the Home Page.
5	OK	Enter the selected option or perform the selected operation.
6		Press to navigate the on-screen menu.
7	←BACK	Return to the previous menu.
8		Press + or - to adjust volume level.
9	YouTube	Press to open the YouTube.
10	SOURCE	Press to open the input source list.
11	≡ MENU	Press to open or close the on-screen menu.
12	Google Assistant	Press to open the google assistant or start a voice search.
13	CH+/CH-	Press CH+ or CH- to change TV channels.
14	MUTE	Press to switch the sound on or off.

Remove the cover of the battery compartment.
Insert the 2 supplied batteries (Type AAA 1.5V).



INITIAL SETUP

The first time you turn on your TV, the setup wizard will guide you through setting up basic settings.

Please according to the Text Tip to First Time Setup.



This function is used for the remote control pair code. After the code is successful, you can use the Bluetooth remote control to operate the TV.



Press **▲/▼** to select the system language and press **OK** to confirm the language.



Connect your Android phone to your TV, select **Continue** to continue the connection, and choose **Skip** to skip this step.



Press **▲/▼** to select the wifi to connect, press **OK** and enter the password to confirm the connection is successful.



By accepting the Google Terms of Service to improve the product experience, select **Accept** to accept this condition.



Agree to Google to get the location information of your device to get more features, choose **YES** to accept.



By agreeing to automatically send diagnostic information to Google to improve discriminative power, choose **YES** to accept.



1. Your device is powered by Android TV and press the **▶** button to select the browsing feature.
2. You can get more apps from Google Play and press the **▶** button to go to the next screen.
3. Transfer photos and other content to the TV via the built-in chromecast, press **OK** to complete the browsing.



Press **▲/▼** to select the country of your device and press **OK** to confirm.



Used to set your device's password to ensure security and privacy.



Press **OK** to pop up the soft keyboard, and use the remote control to enter the 4-digit password automatically jump to the next interface.



Confirm the password again and keep it consistent. Use the remote control to enter the password and complete the password confirmation.



For selecting the mode, press **▲/▼** key to select Home mode and press **OK** to confirm.

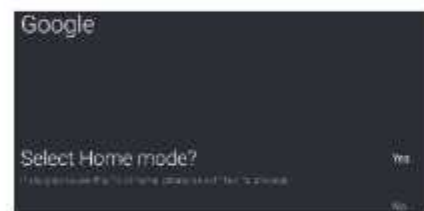

Confirm the selected mode again, select "Yes" to confirm the selected mode, and select "No" to return to the previous step.



Press **▲/▼** to turn on or off the always available features of Chromecast.

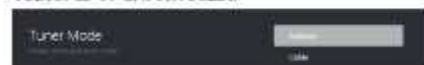

To select the Tuner mode for searching, press **▲/▼** to select and press **OK** to confirm.



Press **▲/▼** to select whether to search, select "Scan" to search, select "Skip scan" to skip the search.

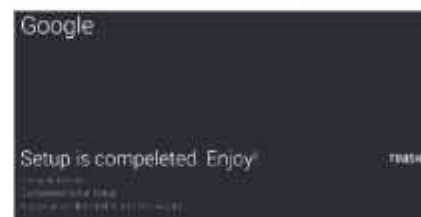

Press **OK** to complete the setup.

HOME SCREEN

After completing the wizard Settings, you can watch TV and go to the home screen.



- ① Open the google assistant or start a voice search.
- ② Among the applications installed on the TV, the icons for the favourite applications are shown inside here. (Favourite applications can be added/deleted/changed its order by users.)

Apps: Click to jump to Apps screen where all the installed applications are listed,

Notification: Display the notifications.

Inputs: Icon to select an input source.

Network&Internet: Icon to Set up Network, Such as wifi.

Settings: Various settings can be configured here.

For details on the settings, see the next explanation.

INPUT SOURCE

1. In the HOME Interface, press **▲/▼/◀/▶** to select the "Inputs" icon, press **OK** to open the input source list, then press up to highlight an input and press **OK** to switch.



2. Under live TV, press the **SOURCE** button to display the list of input sources. You can select the desired source.



NAVIGATING THE ON-SCREEN MENU

1. There are two ways to enter. First, in live TV, press the menu button to display TV options, press **▲/▼/◀/▶** to select the settings menu and press **OK** to confirm. Second, in the HOME interface, press the **▶** key to select the icon of the circular settings menu, press **OK** to confirm.



2. Press **▲/▼** button to select what you want set.
3. Press **OK** to enter setting.



Press **BACK** to return to the previous menu. If the main menu is displayed, pressing **BACK** will close the onscreen menu.

Network

1. Press **▲/▼** button to select what you want set.
2. Press **OK** button to adjust.
3. After finishing your adjustment, Press **OK** button to save and return to the previous menu.



CHANNEL



Channels – Display the scan **sub-menu** based on different Channel installation modes.

Channel installation mode – Select on-screen display channel sources. You can select the signal type.

• **Antenna** – Set the signal type to antenna. When set to Antenna, the TV can receive analog and digital (DVB-T2) broadcasting signals.

• **Cable(Optional)** – Set the signal type to cable. When set to Cable, the TV can receive analog and QAM broadcasting signals

Auto Channel Update – Press OK button to choose ON/OFF. When selecting ON, the system will automatically scan and update channels after 5 minutes of standby.

Parental controls – Press ▲/▼ button to select the option then press OK button to enter the sub-menu.

Audio Channel – Press ▲/▼ button to select the option then press OK button to enter the sub-menu.

Open source licenses – Press ▲/▼ button to select the option then press OK button to enter the sub-menu.

Antenna



1. Menu->Settings->Channel->Channel Installation Mode enter, choose Antenna.



2. Enter Menu->Settings->Channel->Channels.



3. Channel Scan directly enters the ATV+DTV automatic search platform interface of Antenna.

Update Scan: Re-automatically search for frequency points outside the station.



Analog Manual Scan: Manual ATV search station. After input the frequency point, you can select up or down search station.

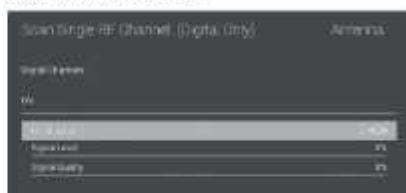

Single RF Scan: DTV manual search, left and right after selecting RF Channel, directly OK search.

Cable



1. Menu->Settings->Channel->Channel Installation Mode, select Cable.

2. Enter Menu->Settings->Channel->Channels.



3. Enter Channel Scan, where Akado, Divan TV, Online and Rostelecom (SPB) are the local operators, and the default Scan Mode is Advance; Others have Advance, Quick and Full Scan modes.



Single RF Scan: manual search station

ACCOUNTS & SIGN IN



APPS



In this menu, you can set the APP permissions, and read the app lists

1. Press ▲/▼ button to select what you want set.
2. Press OK button to adjust.
3. After finishing your adjustment, Press BACK button to return to the previous menu.

DEVICE PREFERENCES

ABOUT



In this menu, you can read the information and settings of TV.

1. Press ▲/▼ button to select what you want set.
2. Press OK button to adjust.
3. After finishing your adjustment, Press BACK button to return to the previous menu.

DATE&TIME



Automatic date & time – Press ▲/▼ button to select the option then press OK button to enter the sub-menu. (Optional: Use network-provided time, Off)

NOTE

• Manually adjusting date & time settings will automatically change the **Automatic date & time** to OFF.

Set date – Press ▲/▼ button to select the option then press OK button to enter the sub-menu.

Set time – Press ▲/▼ button to select the option then press OK button to enter the sub-menu.

Set time zone – Press ▲/▼ button to select the option then press OK button to enter the sub-menu.

Use 24-hour format – Press ▲/▼ button to select the option then press OK button to choose ON/OFF.

TIME



Power On Time Type – Press ▲/▼ button to select the option then press OK button to choose ON/OFF/ONCE.

Auto Power On Time – Press ▲/▼ button to select the option then press OK button to enter the sub-menu. (This option is valid when the **Power On Time Type** is selected as On /ONCE.)

Power Off Time Type – Press ▲/▼ button to select the option then press OK button to choose ON/OFF/ONCE.

Auto Power Off Time – Press ▲/▼ button to select the option then press OK button to enter the sub-menu. (This option is valid when the **Power Off Time Type** is selected as On /ONCE.)

LANGUAGE



Language – Press ▲/▼ button to select the option then press OK button to enter the select language.

KEYBOARD



Current keyboard – Press ▲/▼ button to select the option then press OK button to enter the sub-menu.

Keyboard Settings – Press ▲/▼ button to select the option then press OK button to enter the sub-menu.

Manage keyboards – Press ▲/▼ button to select the option then press OK button to enter the sub-menu.

INPUTS



Inputs – Press ▲/▼ button to select the option then press OK button to enter the sub-menu.

HDMI control – Press ▲/▼ button to select the option then press OK button to choose ON/OFF.

Device auto power off – Press ▲/▼ button to select the option then press OK button to choose ON/OFF.

TV auto power on – Press ▲/▼ button to select the option then press OK button to choose ON/OFF.

HDMI EDID Version – show EDID version.

CEC Device List – Press ▲/▼ button to select the option then press OK button to enter the sub-menu.

POWER



Sleep Timer – Press ▲/▼ button to select the option then press OK button to enter the sub-menu. (Optional: off, 10 minutes, 20 minutes, 30 minutes, 40 minutes, 50 minutes, 60 minutes, 90 minutes, 120 minutes).

Picture off – Press ▲/▼ button to select the option then press OK button to choose ON/OFF.

Switch off timer – Press ▲/▼ button to select the option then press OK button to enter the sub-menu. (Optional: off, 30 minutes, 60 minutes, 90 minutes, 120 minutes, 150 minutes, 180 minutes, 210 minutes, 240 minutes)

No Signal Auto Power Off – Press ▲/▼ button to select the option then press OK button to enter the sub-menu. (Optional: off, 5 minutes, 10 minutes, 15 minutes, 30 minutes, 60 minutes).

PICTURE



Picture Mode – Press ▲/▼ button to select the option button to enter the sub-menu. (Optional; user, Standard, Vivid, Sport, Movie, Game, Energy saving).

Backlight/Brightness/Contrast/Saturation/HUE/Sharpness – Press ▲/▼ button to select the option. Press ◀ to decrease the parameter. Press ▶ to increase the parameter.

Gamma – Press ▲/▼ button to select the option then press OK button to enter the sub-menu. (Optional: Dark, middle, Bright).

Color Temperature – Press ▲/▼ button to select the option then press OK button to enter the sub-menu.

Advanced Video – Press ▲/▼ button to select the option then press OK button to enter the sub-menu.

Reset to Default – Reset all settings to the factory defaults.

SOUND

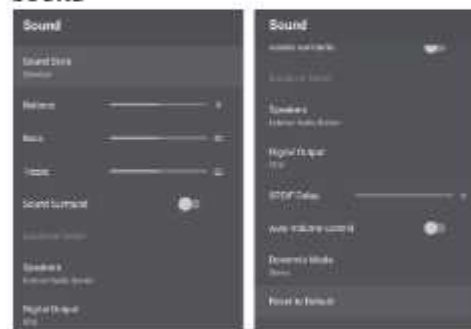

Sound style – Press ▲/▼ button to select the option then press OK button to enter the sub-menu. (Optional: user, Standard, Vivid, Sports, Movie, Music, News).

Balance/Bass/Treble – Press ▲/▼ button to select the option. Press ◀ to decrease the parameter. Press ▶ to increase the parameter.

Sound Surround – Press ▲/▼ button to select the option then press OK button to choose ON/OFF.

Equalizer Detail – Press ▲/▼ button to select the option then press OK button to enter the sub-menu.

Speakers – Press ▲/▼ button to select the option then press OK button to enter the sub-menu. (Optional: TV Speaker, External Audio System).

Digital Output – Press ▲/▼ button to select the option then press OK button to enter the sub-menu. (Optional: Auto, Bypass, PCM, Dolby Digital Plus, Dolby Digital).

SPDIF Delay – Press ▲/▼ button to select the option. Press ◀ to decrease the parameter. Press ▶ to increase the parameter.

Auto Volume Control – Press ▲/▼ button to select the option then press OK button to choose ON/OFF.

Downmix Mode – Press ▲/▼ button to select the option then press OK button to enter the sub-menu. (Optional: Stereo, Surround).

Reset to Default – Reset all settings to the factory defaults.

STORAGE



Internal shared storage – Press ▲/▼ button to select the option then press OK button to enter the sub-menu.

Removable Storage – Press ▲/▼ button to select the option then press OK button to enter the sub-menu. (Note: Show external devices if available)

HOME SCREEN

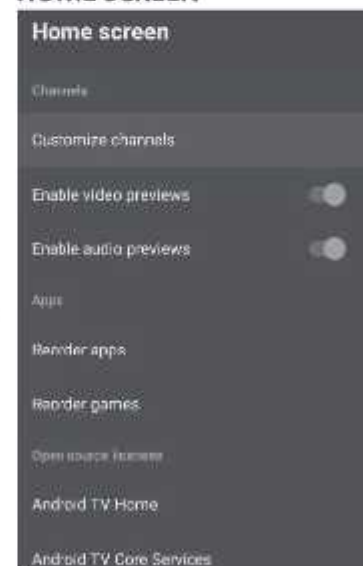

In this menu, you can set channels, apps, open source licenses.

1. Press ▲/▼ button to select what you want set.
2. Press OK button to adjust.
3. After finishing your adjustment, Press BACK button return to the previous menu.

RETAIL MODE



Retail mode – Press ▲/▼ button to select the option then press OK button to choose ON/OFF.

Retail messaging – Press ▲/▼ button to select the option then press OK button to enter the sub-menu. (Note: Demo video, e-POP left, e-POP bottom)

PQ Demo – Press ▲/▼ button to select the option then press OK button to enter the sub-menu.

(Note: OFF, LEFT, RIGHT)

GOOGLE



In this menu, you can set searchable apps, safe search filter, block offensive words, open source licenses.

1. Press ▲/▼ button to select what you want set.
2. Press OK button to adjust.
3. After finishing your adjustment, Press BACK button return to the previous menu.

CHROMECASTBUILT-IN



In this menu, you can read the information and settings of Chromecast

1. Press ▲/▼ button to select what you want set.
2. Press OK button to adjust.
3. After finishing your adjustment, Press BACK button return to the previous menu.

SCREEN SAVER



Screen saver – Press ▲/▼ button to select the option then press OK button to enter the sub-menu. (Optional: Turn screen off, Backdrop, Colors)

When to Start – Press ▲/▼ button to select the option then press OK button to enter the sub-menu. (Optional: 5 minutes, 15 minutes, 30 minutes, 1 hour, 2 hours,).

Put device to sleep – Press ▲/▼ button to select the option then press OK button to enter the sub-menu. (Optional: 30 minutes, 1 hour, 3 hours, 6 hours, 12 hours, Never).

Start now – Press ▲/▼ button to select the option then press OK button to enter screen saver.

LOCATION



Location status – Press ▲/▼ button to select the option then press OK button to enter the sub-menu. (Optional: Use Wi-Fi to estimate location, Off)

USAGE & DIAGNOSTICS



Usage & diagnostics – Press ▲/▼ button to select the option then press **OK** button to choose ON/OFF.

ACCESSIBILITY

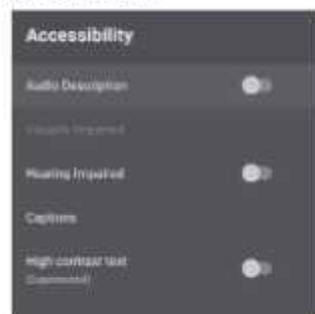

Audio Description– Press ▲/▼ button to select the option then press **OK** button to choose ON/OFF.

Visually Impaired – Press ▲/▼ button to select the option then press **OK** button to enter the sub-menu. (Need:Audio Description)ON

Hearing Impaired – Press ▲/▼ button to select the option then press **OK** button to choose ON/OFF.

Captions – Press ▲/▼ button to select the option then press **OK** button to enter the sub -menu

High contrast text – Press ▲/▼ button to select the option then press **OK** button to choose ON/OFF.

RESET

Press **OK** button to enter the sub-menu.

Reset-Erase everything.

REMOTE&ACCESSORIES



In this menu,you can pair Bluetooth devices.

- 1.Press the **"RED"** and **"BLUE"** buttons at the bottom of the remote control for 5 seconds.
- 2.When the LED starts to flash, release it. The remote controller will send the pairing signal to the TV and display the information of the remote control on the right side of the screen.
- 3.Press the **OK** button to display the pairing. If the paired is displayed, the connection is successful.
- 4.If the couldn't pair appears, the connection fails. Wait 30 seconds and then press the **"RED"** and **"BLUE"** buttons at the bottom of the remote control for 5 seconds to repeat the previous steps.
- 5.Press **EXIT** or **BACK** button return to the previous menu.

ADD AND USE OF MULTI MEDIA PLAYER



1. In the HOME interface, select the + icon in the APP column to add the application, and click OK. Press up and down to select the MultiMediaPlayer application, and click OK to add it to the HOME interface.



2. Select OK key to enter Multi Media Player and display Video, Photo, Audio. After inserting the usb flash drive, you can view the corresponding files in the usb flash drive.

















NOTE

The menu/function may be different depending on when you purchased the TV.

Read Before Using Apps

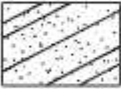
(*Terms & Conditions apply)

- Due to the product characteristics featured on the Apps store, as well as limitations in available content, certain featured applications, and services may not be available on all devices or in all territories. Some Apps featured may also require additional peripheral device or membership fees. Services and content availability are subject to change without prior notice.
- Manufacture takes no legal responsibility whatsoever for any interruption of App services caused by the service provider for any reason.
- An unstable Internet connection may cause delays or interruptions. In addition, applications may terminate automatically depending on the network environment.
- Applications services and updates may become unavailable.
- Application content is subject to change by the services provider without prior notice.
- Specific services may differ with the version of the application installed on the TV.
- An application's functionality may change in future version of the application.
- Depending on the third party service provider's policies, certain applications may not support multitasking.
- The response to remote commands and the resulting on-screen display may be delayed while a webpage is loading.
- The copy and paste operations are not supported.
- The web browsing speed will differ with the network environment.
- Depending on the types of video/audio codecs supported, it might not be possible to play certain video and audio files while playing content.
- Apps store have certain limitation, it consist many inbuilt apps for various needs of user but user doesn't have facility to add other apps from any other media.

Trouble phenomenon		Inspection
Picture	Audio	
 Snow	 Noise	antenna position, direction or connection
 Ghost	 Normal audio	antenna position, direction or connection
 Interfere	 Noise	electronic equipment, car/ motorcycle, fluorescent light
 Normal Picture	 Mute	Volume (inspect whether the mute function on the remote control are started, or audio system are correct or not)
 No picture	 Mute	Power cord is not inserted Power switch is not opened Contrast and brightness/volume setup Press standby key on the remote control for inspecting
 No color	 Normal audio	color control
 Scramble	 Normal audio or weak	retune channel
 No color	 Noise	Audio system

Special Explanation: The accessories such as remote control is not belongs to the guarantee.

Haier

